

Zubehör:

- 50009-2 Reinigungsbürstensatz
- 51010 Dichtungssatz
- 52025 Werkzeugsatz

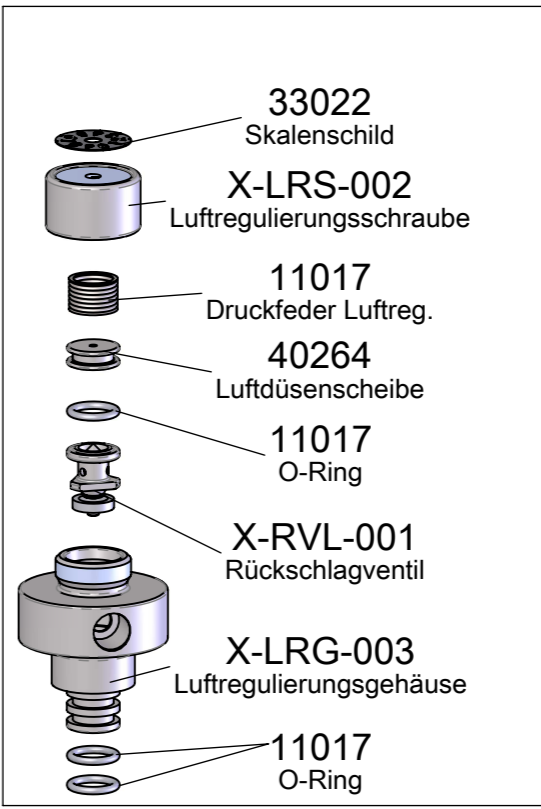
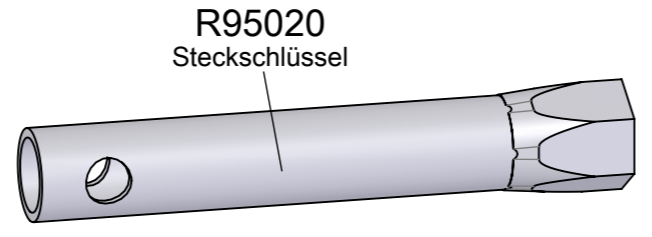
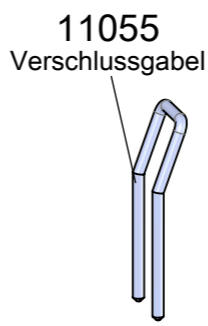
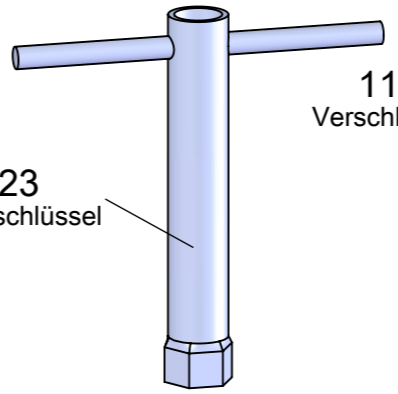
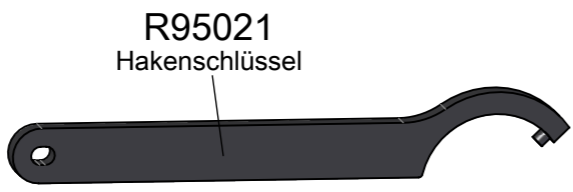

X-LRM-002-1
Luftregulierung
montiert

38000
Obere Abschlusseinheit

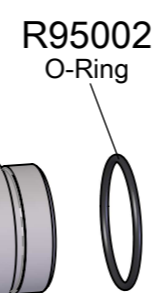
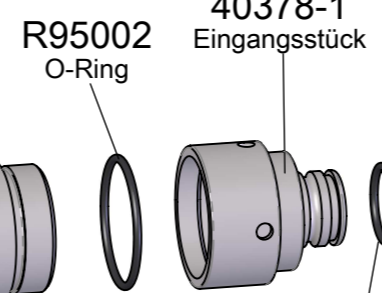
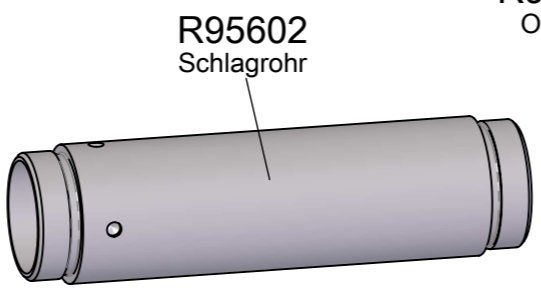
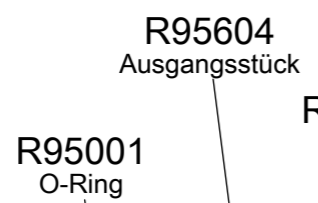
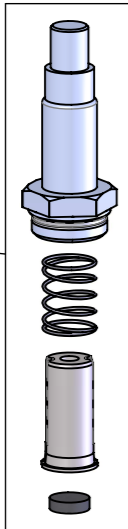

11025
O-Ring

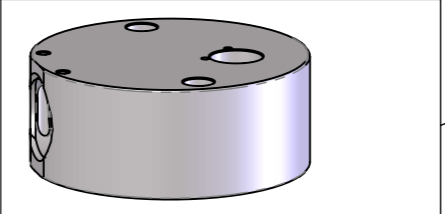

X-VKM-100
Ventilkopf montiert

X-SOM-001
Saugrohr montiert

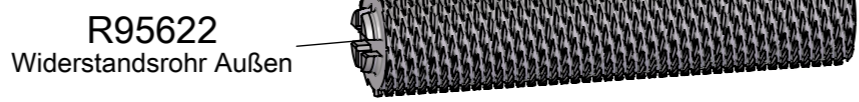
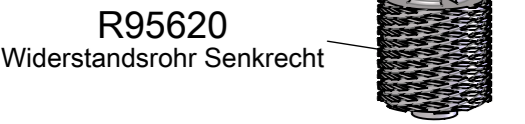
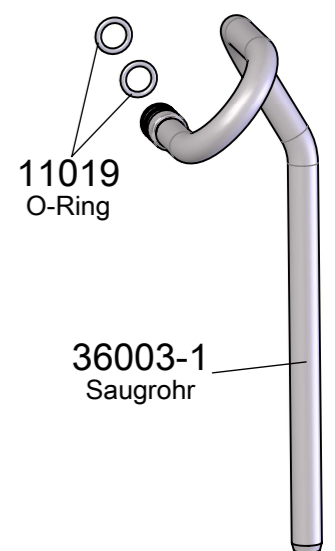
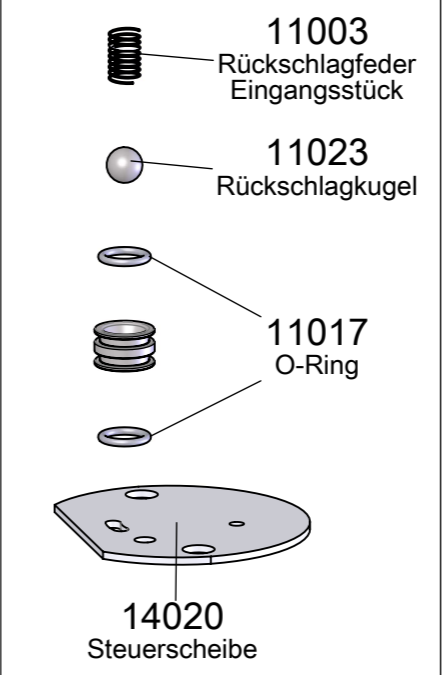
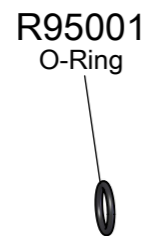
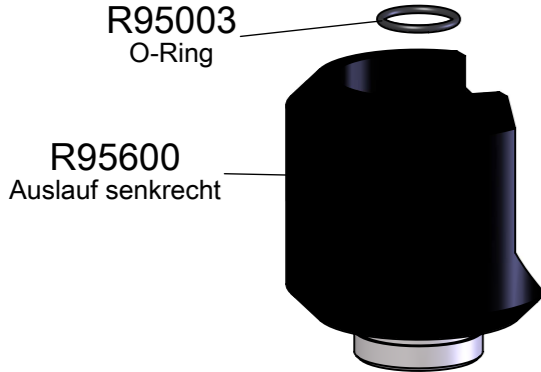

R95001
O-Ring

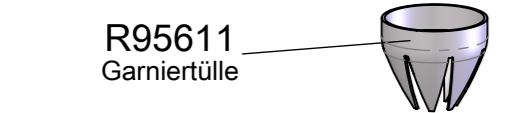
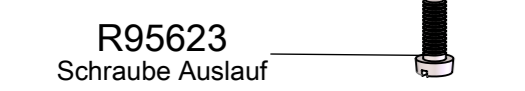
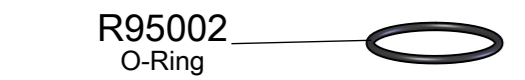

X-PUM-007
Pumpe

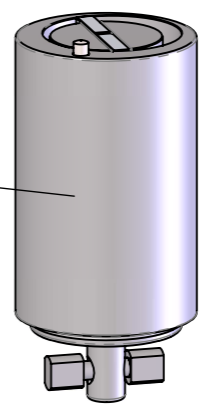

X-SKM-001
Saugkorb montiert

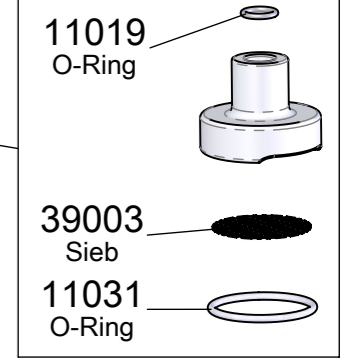

Oberteil **SANOMAT** Rahmator 2L